





Smart gateway

Convert sensor data into industry-standard format and get access to near real-time data locally or in the cloud.

Our smart gateway receives live data from multiple sensors, converts it into easy-to-use JSON format and makes it available locally or in the cloud, via MQTT. Enabling you to easily integrate live sensor data into your existing software application or IoT platform.

Features

-  Receives EnOcean sensor telegrams via the EnOcean wireless radio protocol. Converts sensor data into JSON (JavaScript Object Notation).
-  Transmits data via ethernet cable, WiFi or LTE (4G) (ethernet only version available). Failovers can be configured to automatically switch to a backup connection if needed.
-  Sends data to up to 5 user-defined MQTT brokers. Includes ready-made connections to IBM Watson IoT, AWS IoT Core, Microsoft Azure IoT Hub, Google Sheets and Node-RED.
-  Small, fanless compact design.
-  Optional built in sensors.



Integrating sensor data

Our smart gateway receives near real-time data from all sensors within range, converts the raw data into an easy-to-use JSON format, then publishes it using MQTT protocol. Data can be sent - via Ethernet, LTE (4G) or WiFi - to any local or cloud MQTT broker; securely to IBM Watson IoT, Microsoft Azure IoT Hub or AWS IoT Core; directly into Google Sheets; or to a Node-RED application.

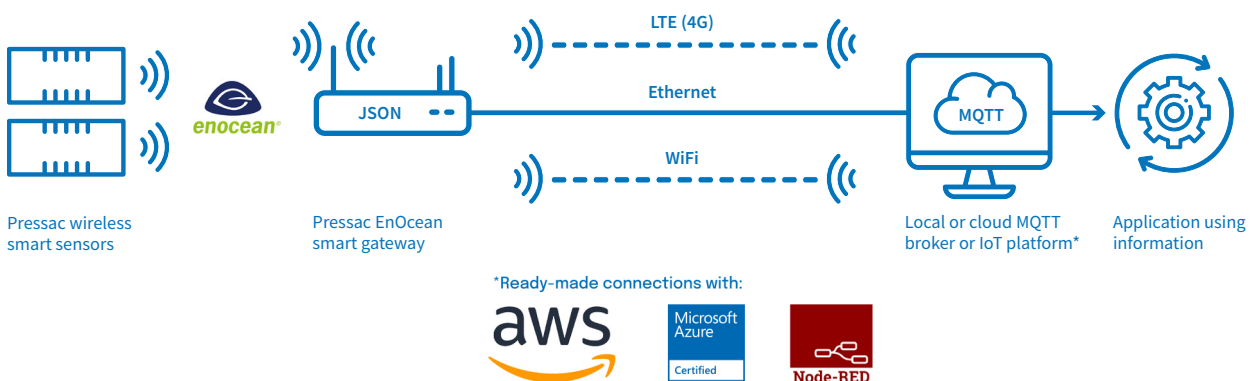

Technical specification

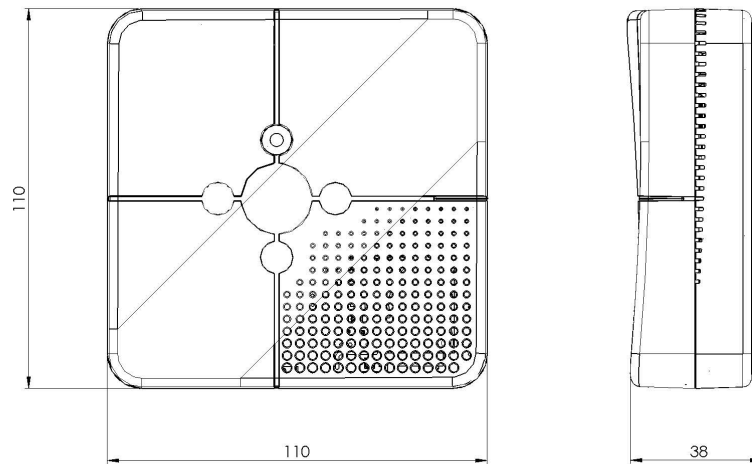

Measurement	<p>CPU: Broadcom BCM2837 quad-core A54 (ARMv8) 64-bit @ 1.4GHz</p> <p>Memory: 1GB RAM</p> <p>Storage: 8GB eMMC</p> <p>LED: red/green/blue displaying functionality</p>
Power specification	<p>Transmit power: 3dBm maximum</p> <p>Receive sensitivity: -97 dBm</p> <p>Power supply: 5V USB to DC mains adapter (supplied)</p> <p>Input voltage: 100-240v AC 50Hz 300mA</p>
Network interfaces	<p>Ethernet: 10/100 ethernet interface</p> <p>Cloud connections: IBM Watson IoT, Microsoft Azure IoT Hub, AWS IoT Core. Other connections are available if required</p>
Wireless specification	<p>Protocol: EnOcean</p> <p>Radio frequency:</p> <ul style="list-style-type: none"> 868 MHz for Europe and other countries adopting RED <p>EnOcean interface: TCM 515</p> <p>EnOcean antenna: internal antenna</p>
Enclosure specification	<p>Material: ABS plastic</p> <p>IP rating: IP2X</p> <p>Dimensions: 110 x 110 x 38 mm (approx)</p>
Installation	<p>Fixing: screws to wall – screws provided – or rubber feet for desktop</p> <p>Operating temperature: -10°C to +55°C</p> <p>Storage temperature: -20°C to +55°C</p> <p>Environment: indoor</p>
Compliance	CE approved, FCC approved (Ethernet-only), RoHS compliant, WEE directive compliant
Part number	GW_E_LIN_E868, GW_ELW_LIN_E868

